

12 660 979













Fits: IMO, LULU, MADISON, MEM, TARA, CL.1, LISSÉ, VAIA, META, CYO

- cover plate 150 x 240 x 15 mm
- flush handle with rotary operation and two-volume technology (full flush/partial flush)

This product is compatible with the following TECE products:

- TECEprofil dry wall construction, article numbers:
9300300, 9300322, 9300301, 9300344, 9300309, 9300303, 9300388, 9300366, 9300102, 9300103
- TECEbox wet wall construction, article numbers:
9370300, 9375300, 9371300

	Brushed Chrome	12 660 979-93
	Chrome	12 660 979-00
	Brushed Platinum	12 660 979-06
	Platinum	12 660 979-08
	Dark Chrome	12 660 979-19
	Light Gold	12 660 979-26
	Brushed Light Gold	12 660 979-27
	Brushed Durabronze (23kt Gold)	12 660 979-28
	Matte Black	12 660 979-33
	Brushed Bronze	12 660 979-42
	Brushed Champagne (22kt Gold)	12 660 979-46
	Champagne (22kt Gold)	12 660 979-47
	Brushed Dark Platinum	12 660 979-99

12 660 979

mm [inches]



12 660 979

Parts for other finishes can be found here: Chrome

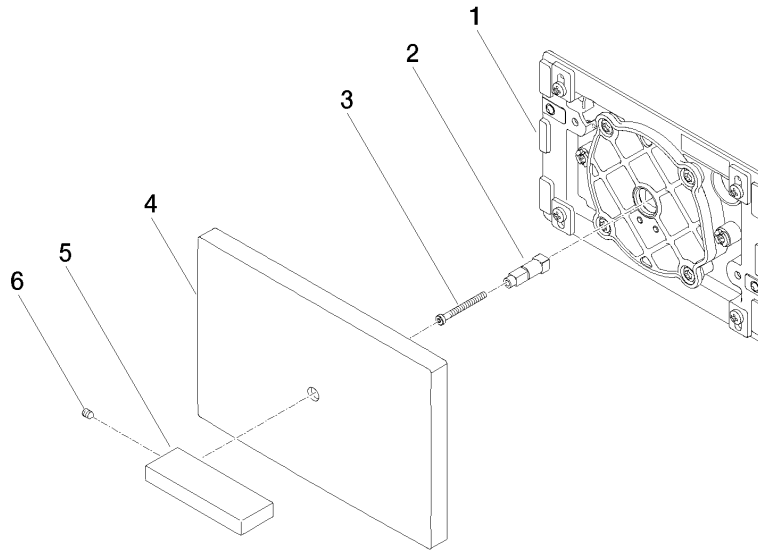

Spare parts list

No.	Item Number	Name	Quantity used	Delivery time
1	04 28 01 053 00 90	plate	1	2
2	09 18 20 038 90	base	1	2
3	09 30 30 086 90	screw	1	2
4	09 11 01 179-93	cover	1	-
Spare part can no longer be ordered, please order the replacement item				
5	09 20 97 057-93	handle	1	20
6	09 31 11 058 90	pin	1	2